



T01-ATN2-SK-0104

TEST DATA

ON

0.5 TO 18 GHz

15.5 dB

HIGH SPEED DIGITAL ATTENUATOR

AMC MODEL No.
ADVAN-218-15DD
OPTION HS25NS, 5B

SERIAL NUMBER: ATN2P1

DESIGNED, TESTED AND REPORTED

BY

S KUHN

15 January 2004

AMERICAN MICROWAVE CORPORATION, 7311G GROVE ROAD, FREDERICK, MD 21704
TEL: 301-662-4700 FAX: 301-662-4938 EMAIL: sales@americanmicrowavecorp.com
WEBSITE: <http://www.americanmicrowavecorp.com>



AMC MODEL No: ADVAN-218-15DD
OPTION HS25NS, 5B

FEATURES:

- **VERY HIGH SPEED < 15 ns**
- **WIDE BANDWIDTH**
- **15.5 dB RANGE**
- **0.5 dB DIGITAL STEP SIZE**



SPECIFICATIONS

#		MIN	MAX	UNIT
1	FREQUENCY RANGE	0.5	18	GHz
2	INSERTION LOSS	2.5	6.0	dB
3	RETURN LOSS		-10	dB
4	SWITCHING TIME		15	ns
5	P1dB 2 to 18 GHz	19		dBm
6	P1dB 0.5 to 2 GHz	15		dBm
7	ATTENUATION FLATNESS ATN < 5 dB 25°C		± 0.5	dB
7	ATTENUATION FLATNESS ATN < 10 dB 25°C		± 0.8	dB
8	ATTENUATION FLATNESS any ATN 25°C		± 1.2	dB
9	POSITIVE SUPPLY VOLTAGE	9	15	V
10	NEGATIVE SUPPLY VOLTAGE	-9	-15	V
11	POSITIVE SUPPLY CURRENT		25	mA
12	NEGATIVE SUPPLY CURRENT		25	mA
13	OPERATING TEMPERATURE RANGE	-40	85	°C



MECHANICAL OUTLINE

AMC MODEL No: ADVAN-218-15DD OPTION HS25NS,5B

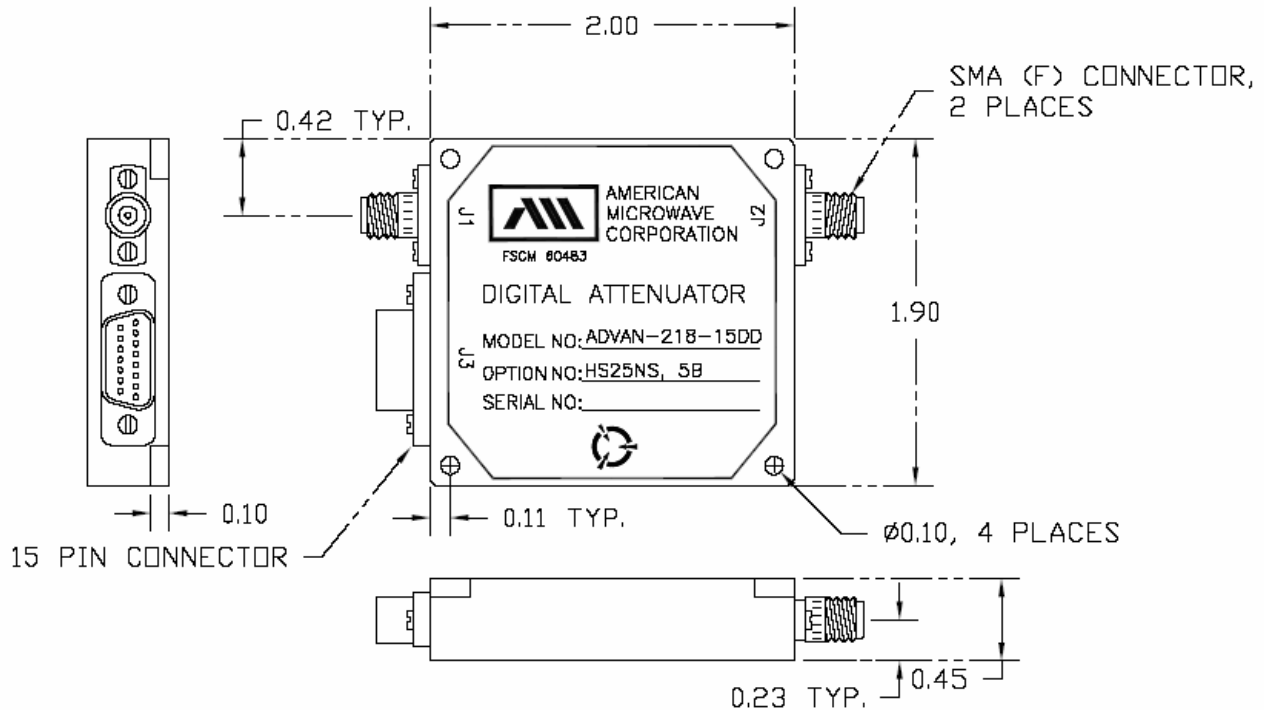

AMC STANDARD ENVIRONMENTAL SPECIFICATIONS

TEMPERATURE	-40°C to +85°C (Operating)
	-65°C to +100°C (Storage)
HUMIDITY	MIL-STD-202F, METHOD 103B, Condition B
SHOCK	MIL-STD-202F, METHOD 213B, Condition B
VIBRATION	MIL-STD-202F, METHOD 204D, Condition B
ALTITUDE	MIL-STD-202F, METHOD 105C, Condition B
TEMPERATURE CYCLE	MIL-STD-202F, METHOD 107D, Condition A
NOTE: THE ABOVE SPECIFICATIONS ARE SUBJECT TO CHANGE OR REVISION	



AMC MODEL No: ADVAN-218-15DD OPTION HS25NS,5B

Measured data from unit : ATN2P1

DIGITAL CODE						PROGRAMMED ATTENUATION	MEASURED AVERAGE ATTENUATION	FLATNESS
HEX	BINARY							
00	0	0	0	0	0	0 dB	0 dB	± 0 dB
04	0	0	1	0	0	2 dB	2.2 dB	± 0.3 dB
08	0	1	0	0	0	4 dB	4.2 dB	± 0.3 dB
0C	0	1	1	0	0	6 dB	6.2 dB	± 0.2 dB
10	1	0	0	0	0	8 dB	8.6 dB	± 0.4 dB
14	1	0	1	0	0	10 dB	10.7 dB	± 0.5 dB
18	1	1	0	0	0	12 dB	12.6 dB	± 0.5 dB
1C	1	1	1	0	0	14 dB	14.6 dB	± 0.6 dB
1F	1	1	1	1	1	15.5 dB	16.3 dB	± 0.8 dB



**ATTENUATION
RETURN LOSS
RELATIVE PHASE SHIFT**

CONTROL BITS : 00000

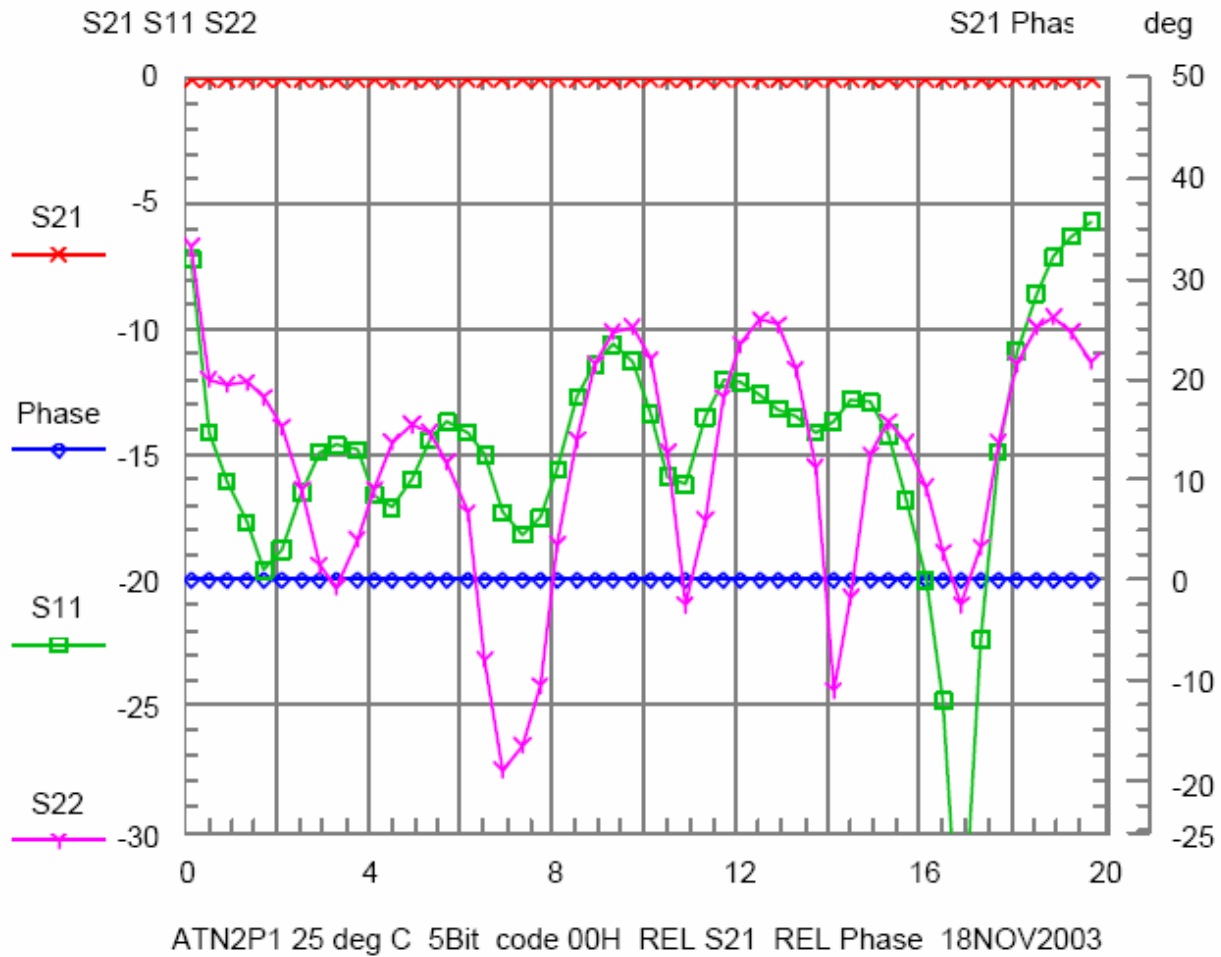



**ATTENUATION
RETURN LOSS
RELATIVE PHASE SHIFT**

CONTROL BITS : 00100

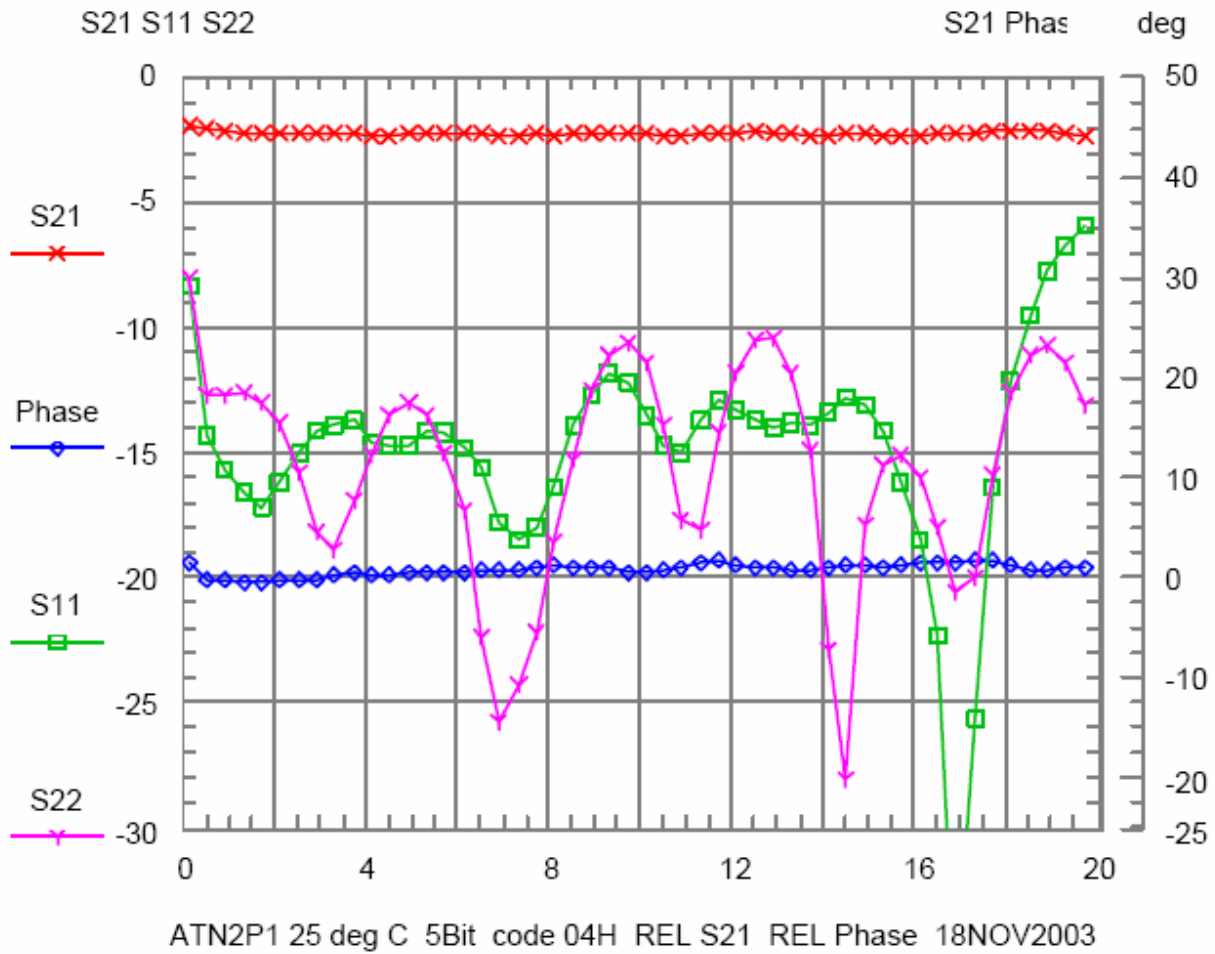



**ATTENUATION
RETURN LOSS
RELATIVE PHASE SHIFT**

CONTROL BITS : 01000

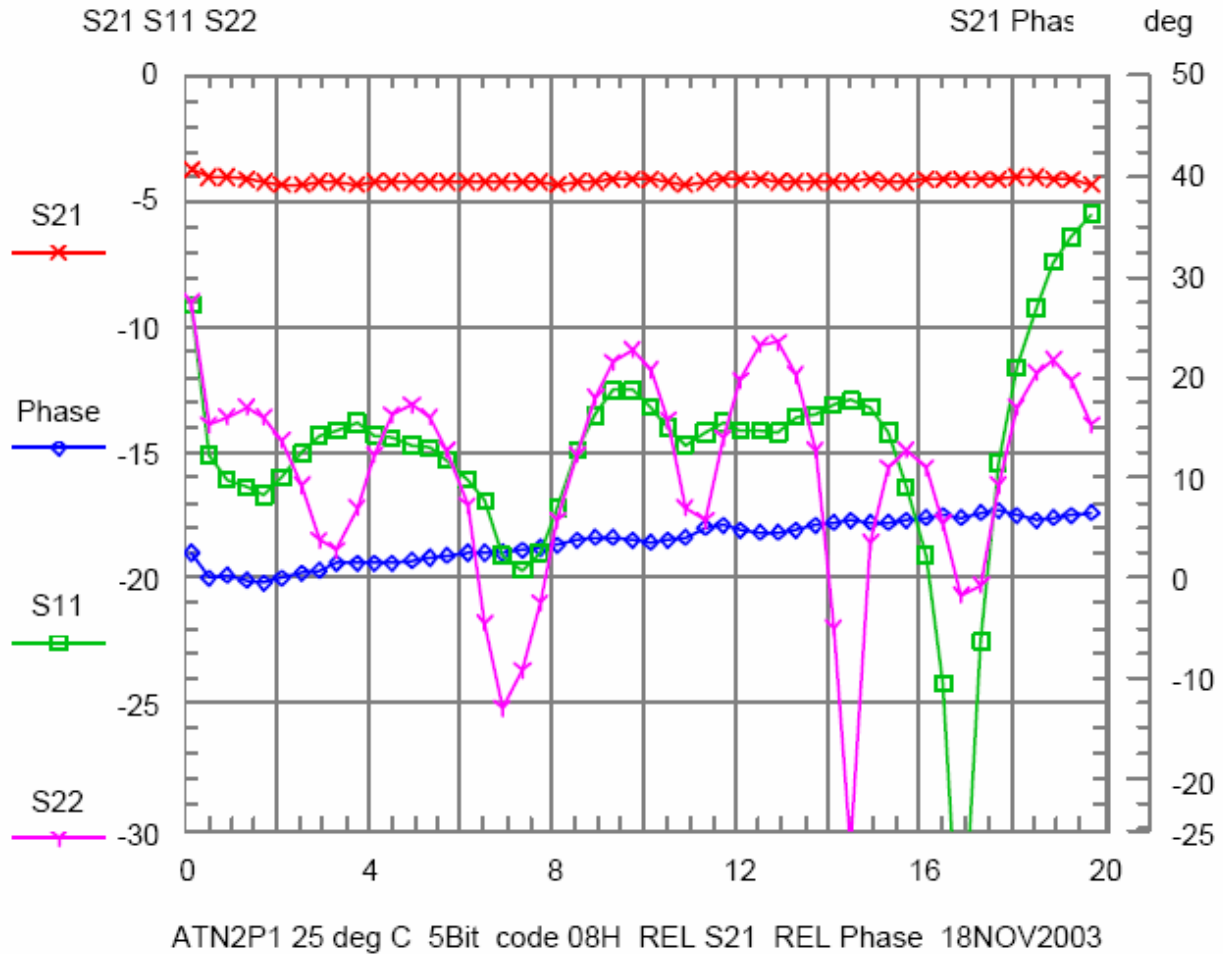



**ATTENUATION
RETURN LOSS
RELATIVE PHASE SHIFT**

CONTROL BITS : 01100

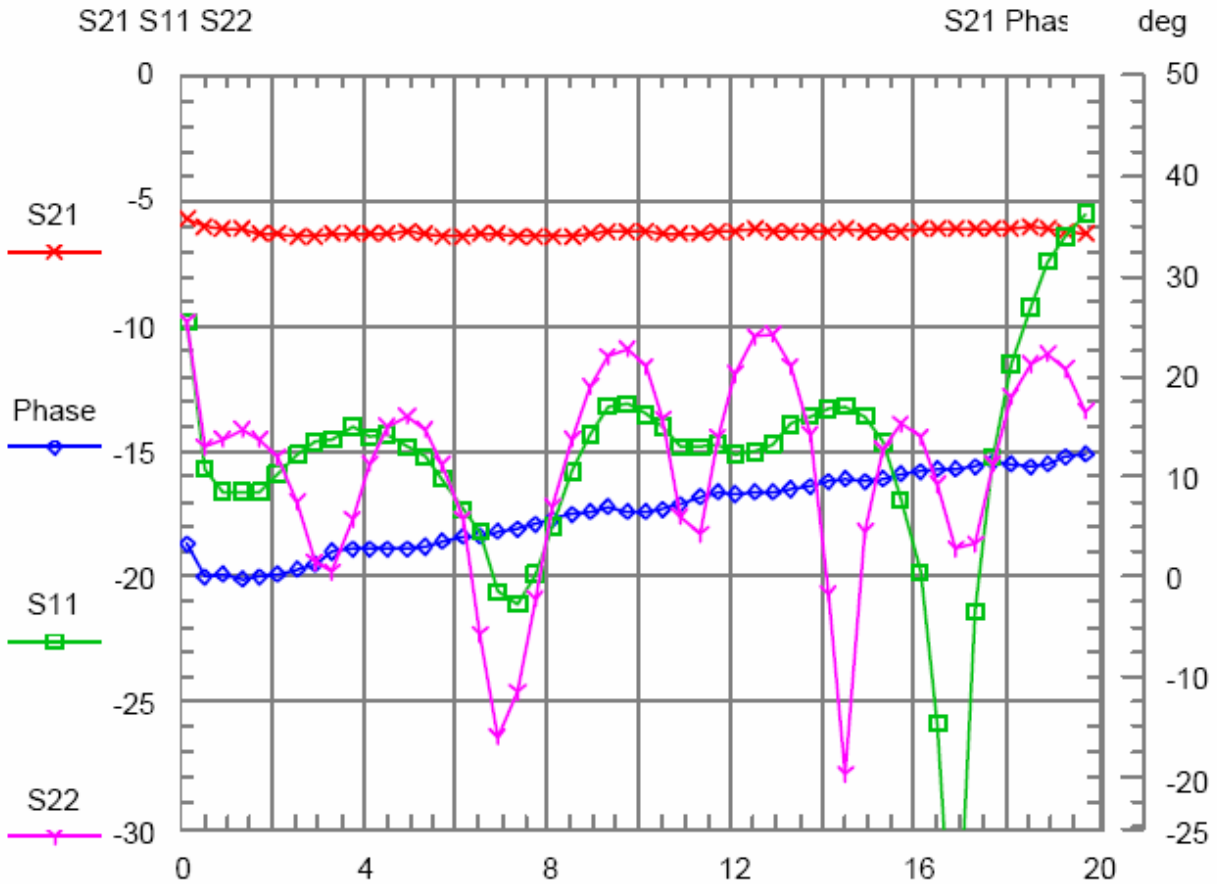

ATN2P1 25 deg C 5Bit code 0CH REL S21 REL Phase 18NOV2003



**ATTENUATION
RETURN LOSS
RELATIVE PHASE SHIFT**

CONTROL BITS : 10000

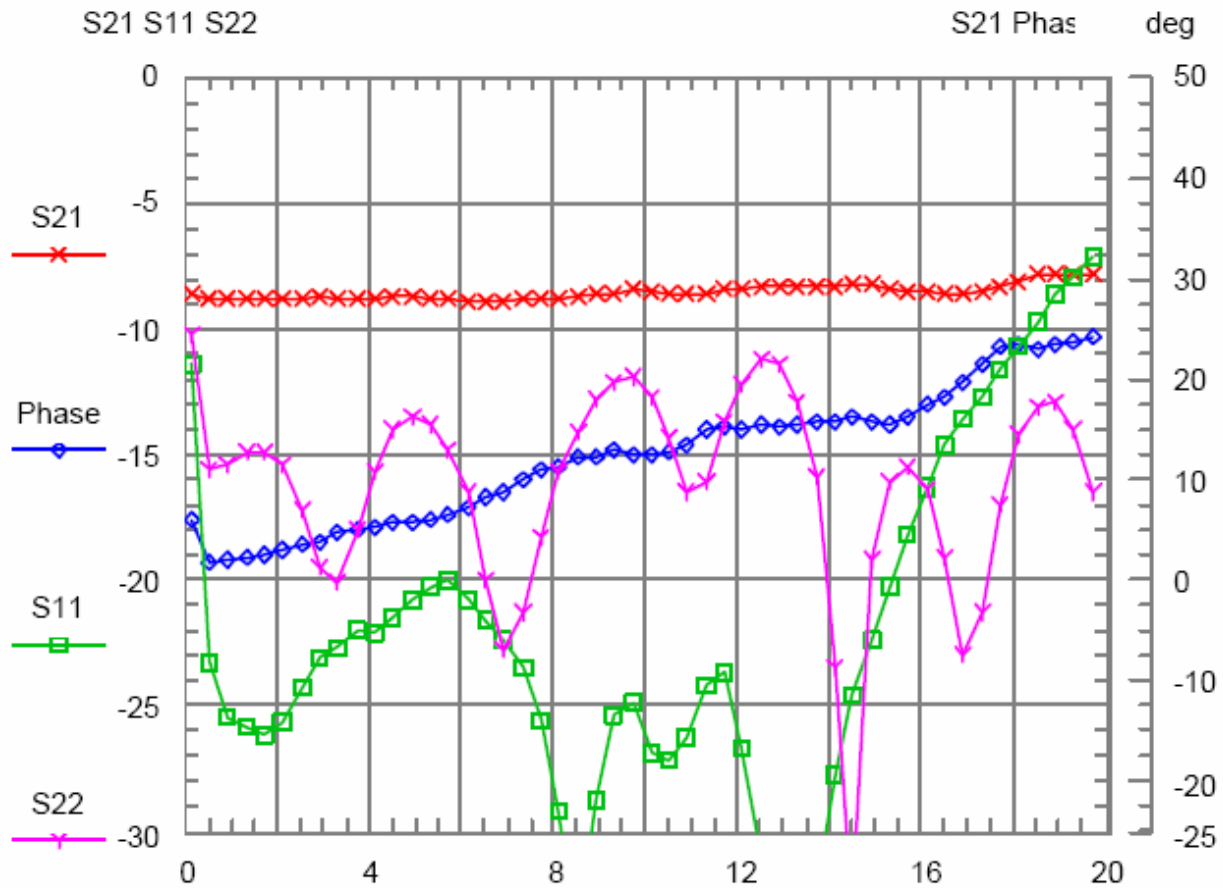

ATN2P1 25 deg C 5Bit code 10H REL S21 REL Phase 18NOV2003



ATTENUATION
RETURN LOSS
RELATIVE PHASE SHIFT

CONTROL BITS : 10100

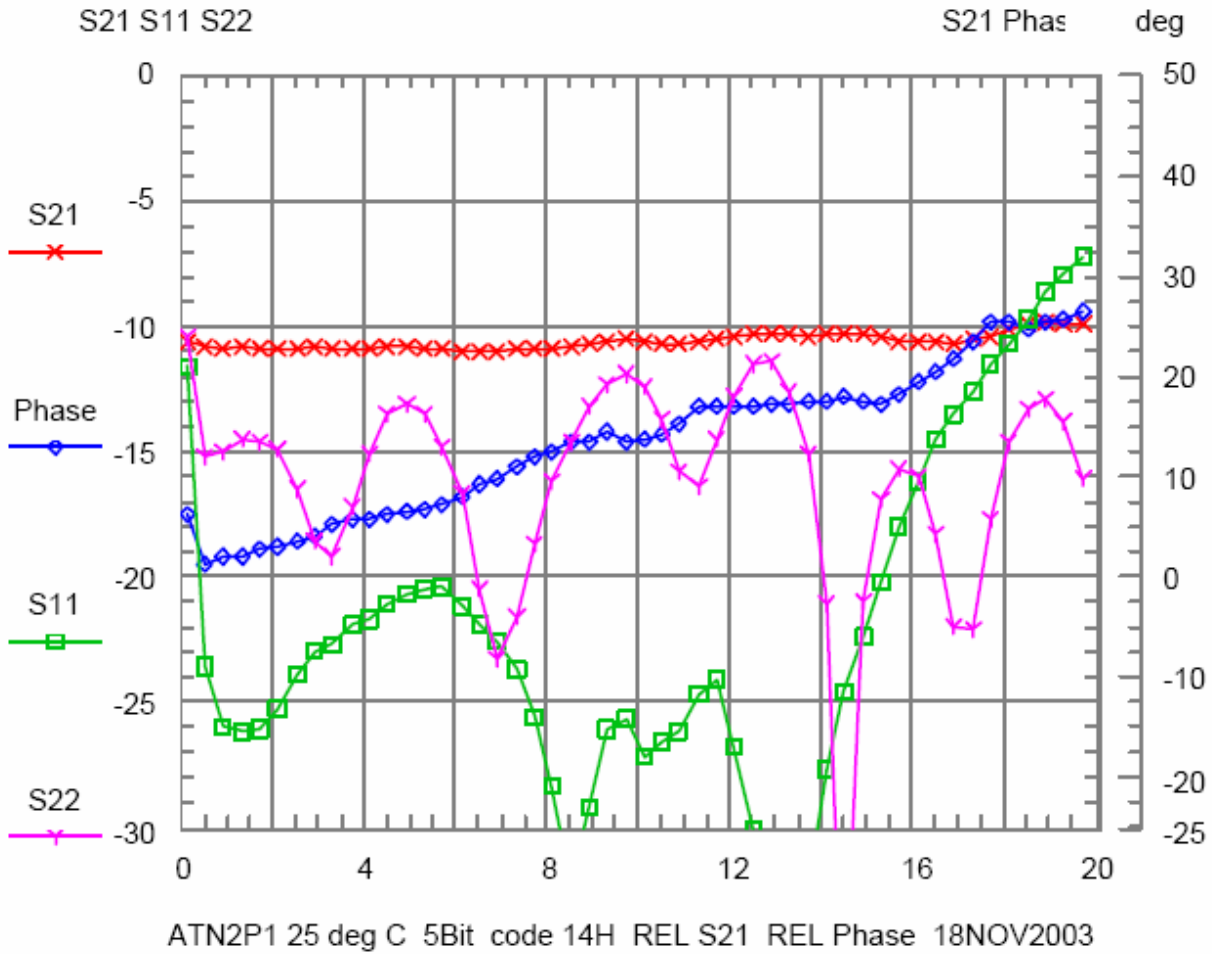



**ATTENUATION
RETURN LOSS
RELATIVE PHASE SHIFT**

CONTROL BITS : 11000

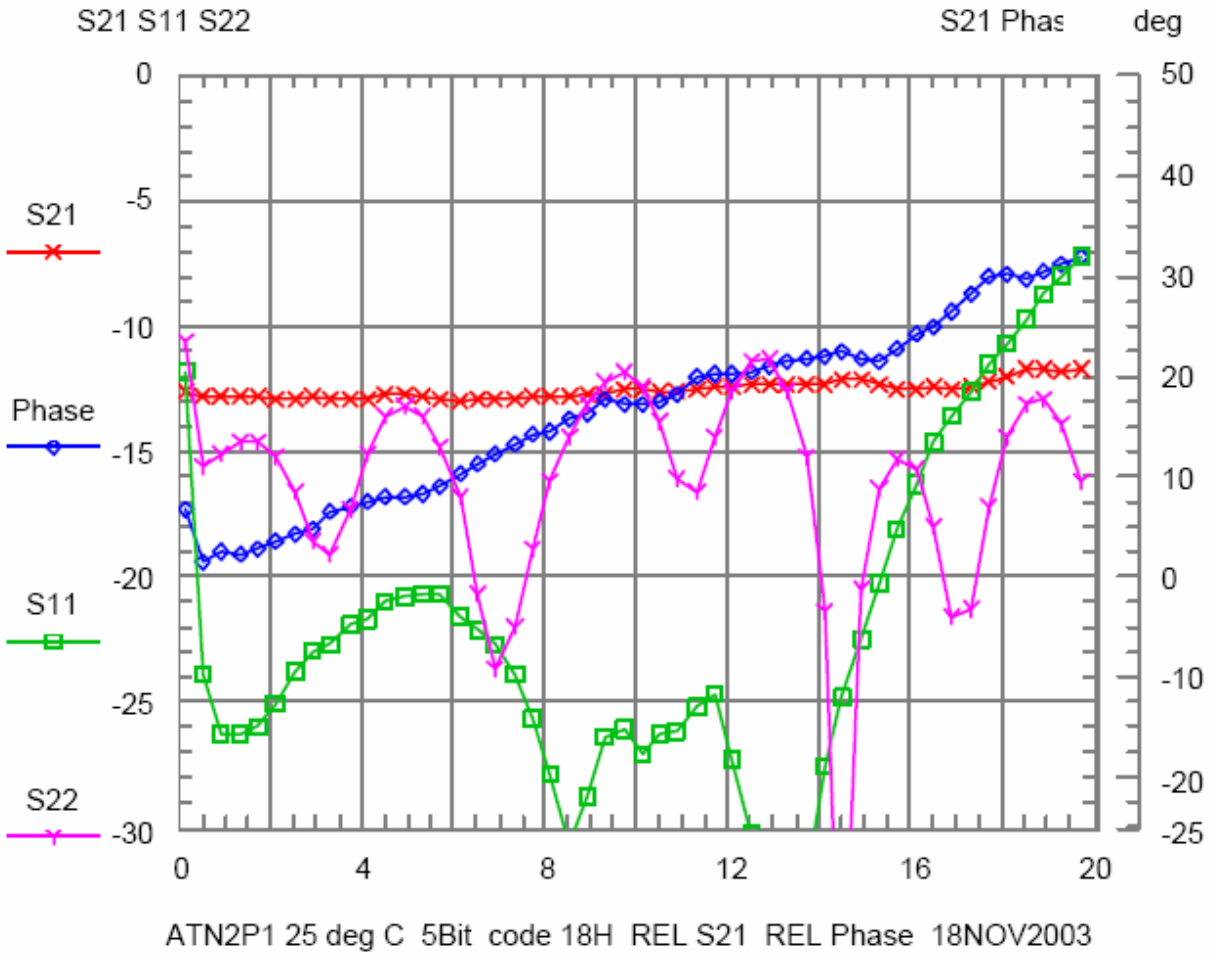



**ATTENUATION
RETURN LOSS
RELATIVE PHASE SHIFT**

CONTROL BITS : 11100

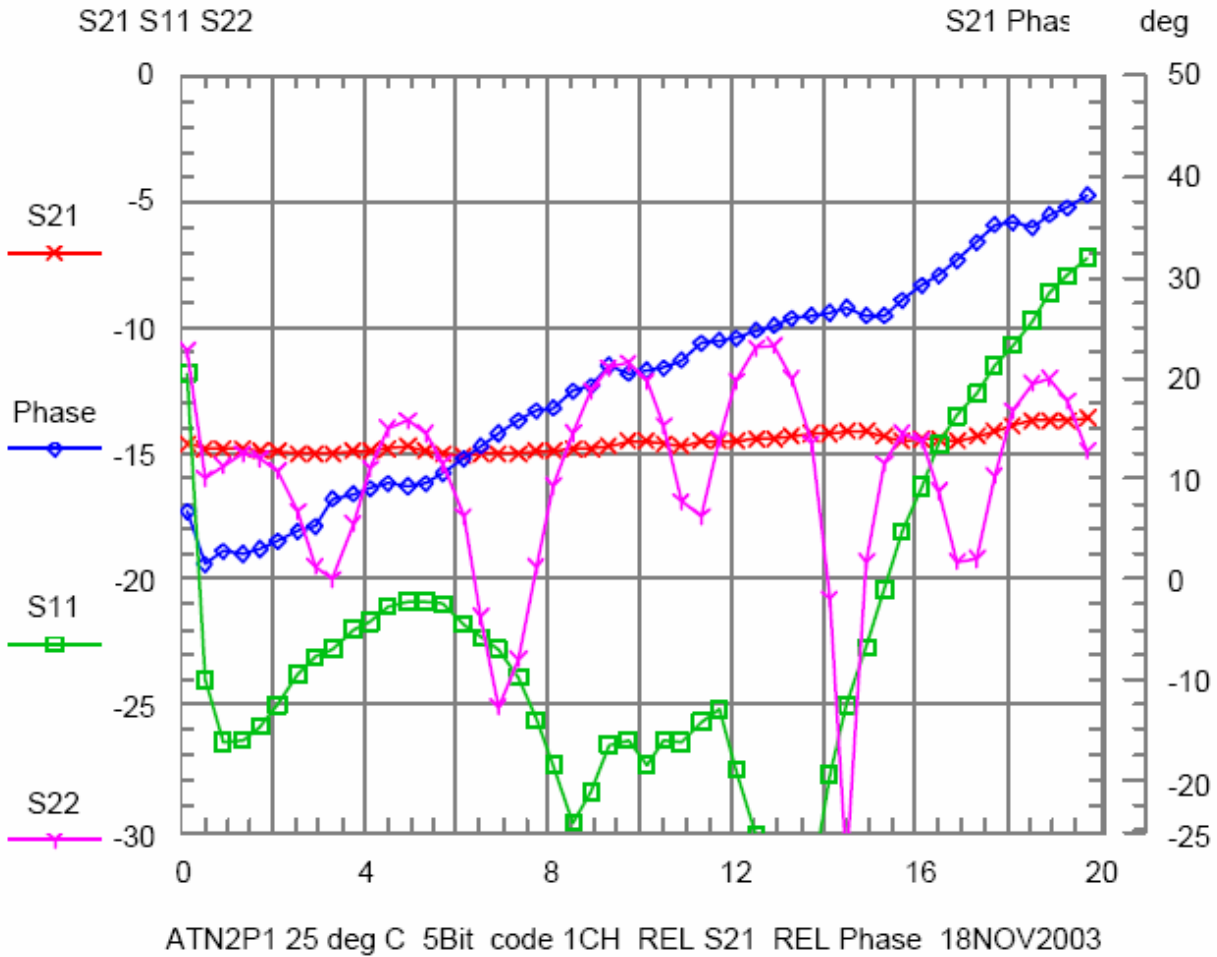



**ATTENUATION
RETURN LOSS
RELATIVE PHASE SHIFT**

CONTROL BITS : 11111

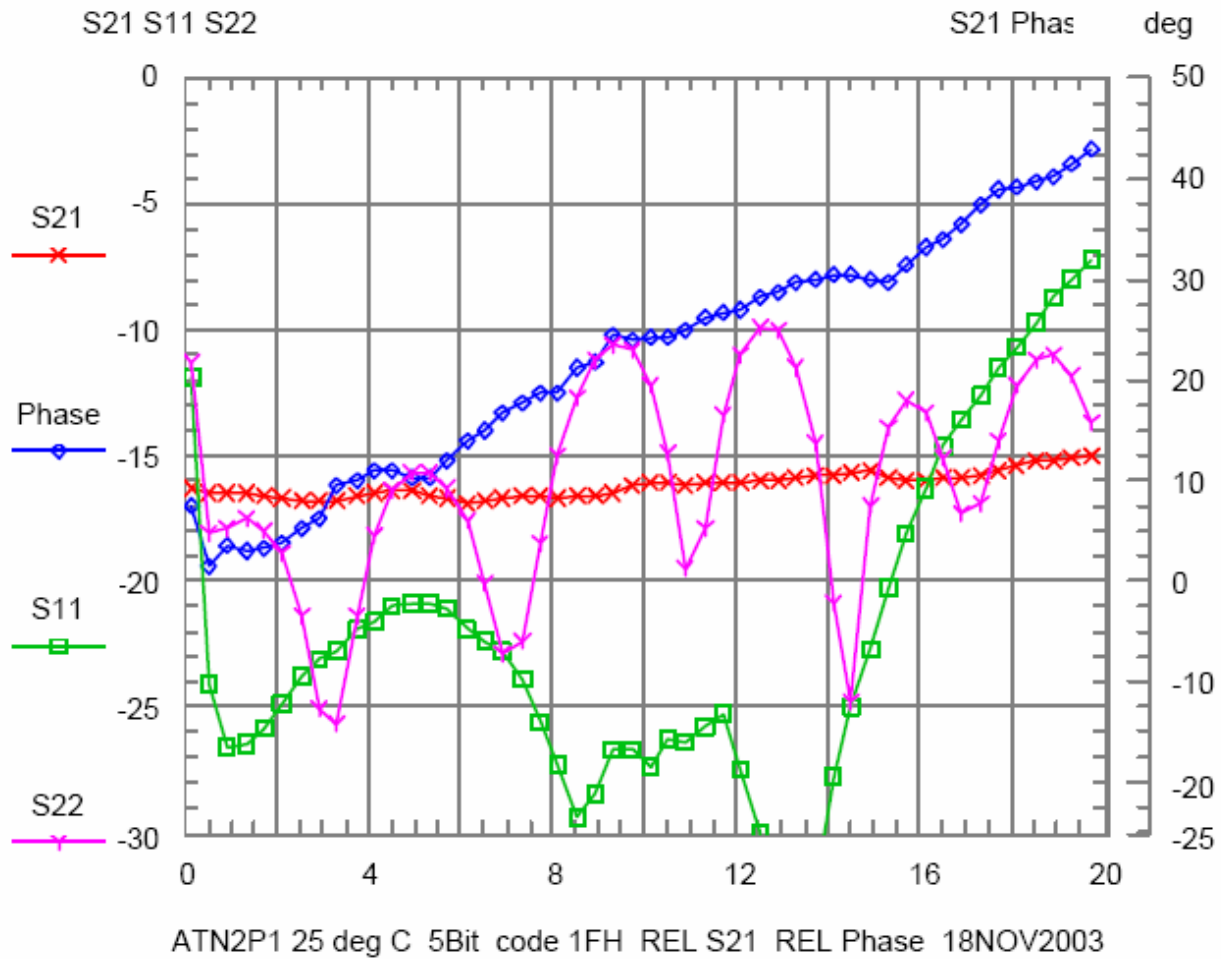



ABSOLUTE INSERTION LOSS
RETURN LOSS
RELATIVE PHASE SHIFT

CONTROL BITS : 00000

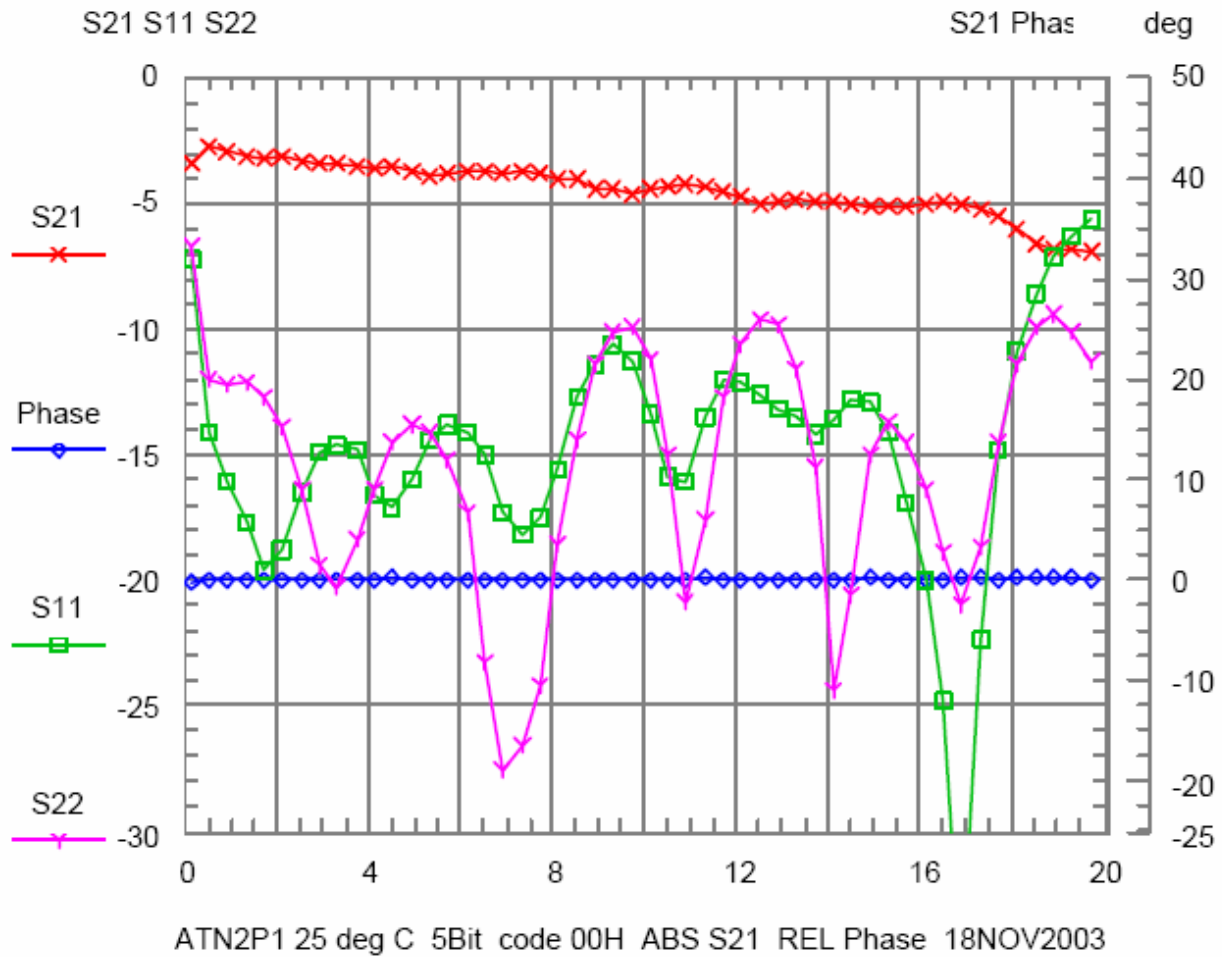



**ABSOLUTE INSERTION LOSS
RETURN LOSS
RELATIVE PHASE SHIFT**

CONTROL BITS : 00100

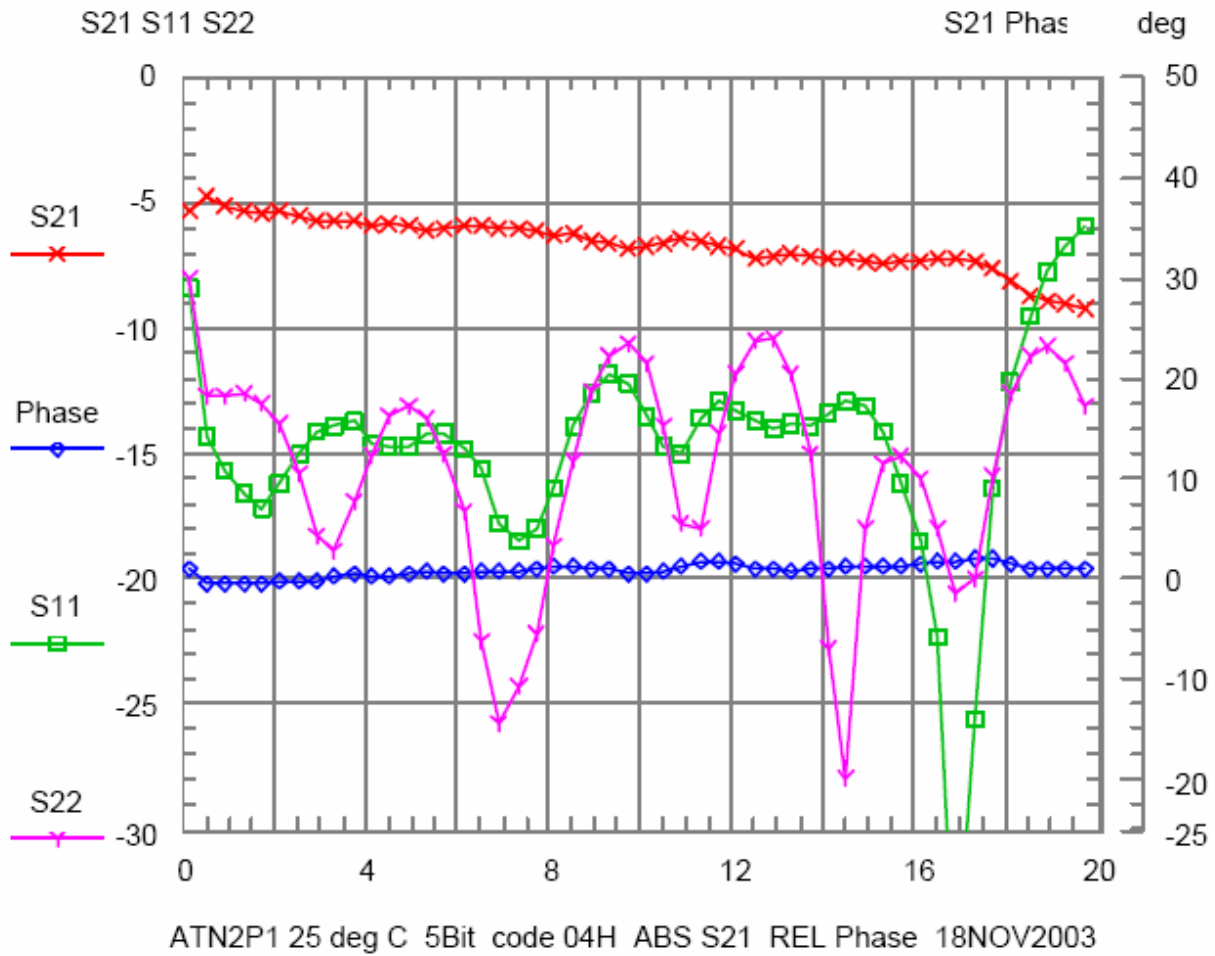



**ABSOLUTE INSERTION LOSS
RETURN LOSS
RELATIVE PHASE SHIFT**

CONTROL BITS : 01000

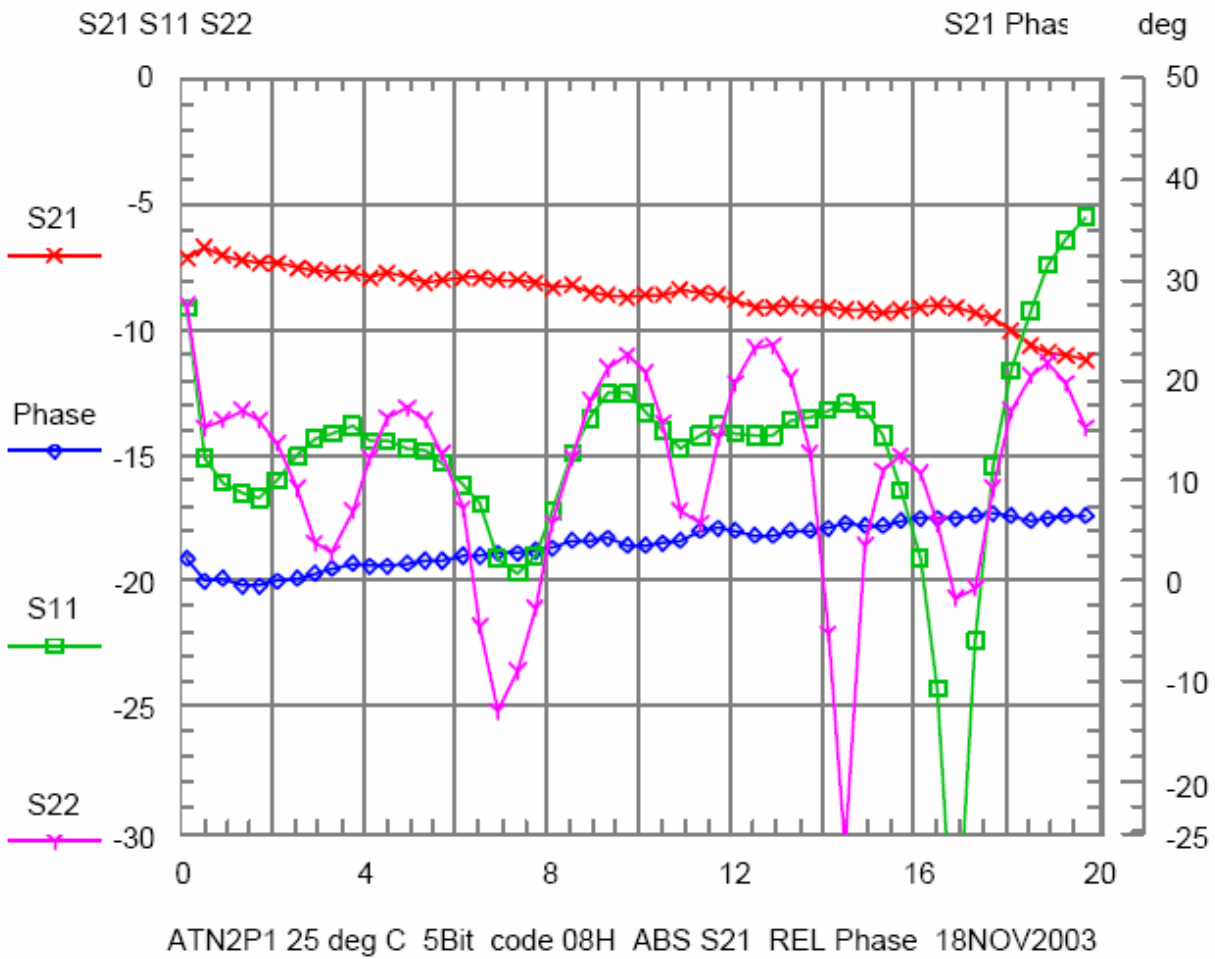



ABSOLUTE INSERTION LOSS
RETURN LOSS
RELATIVE PHASE SHIFT

CONTROL BITS : 01100

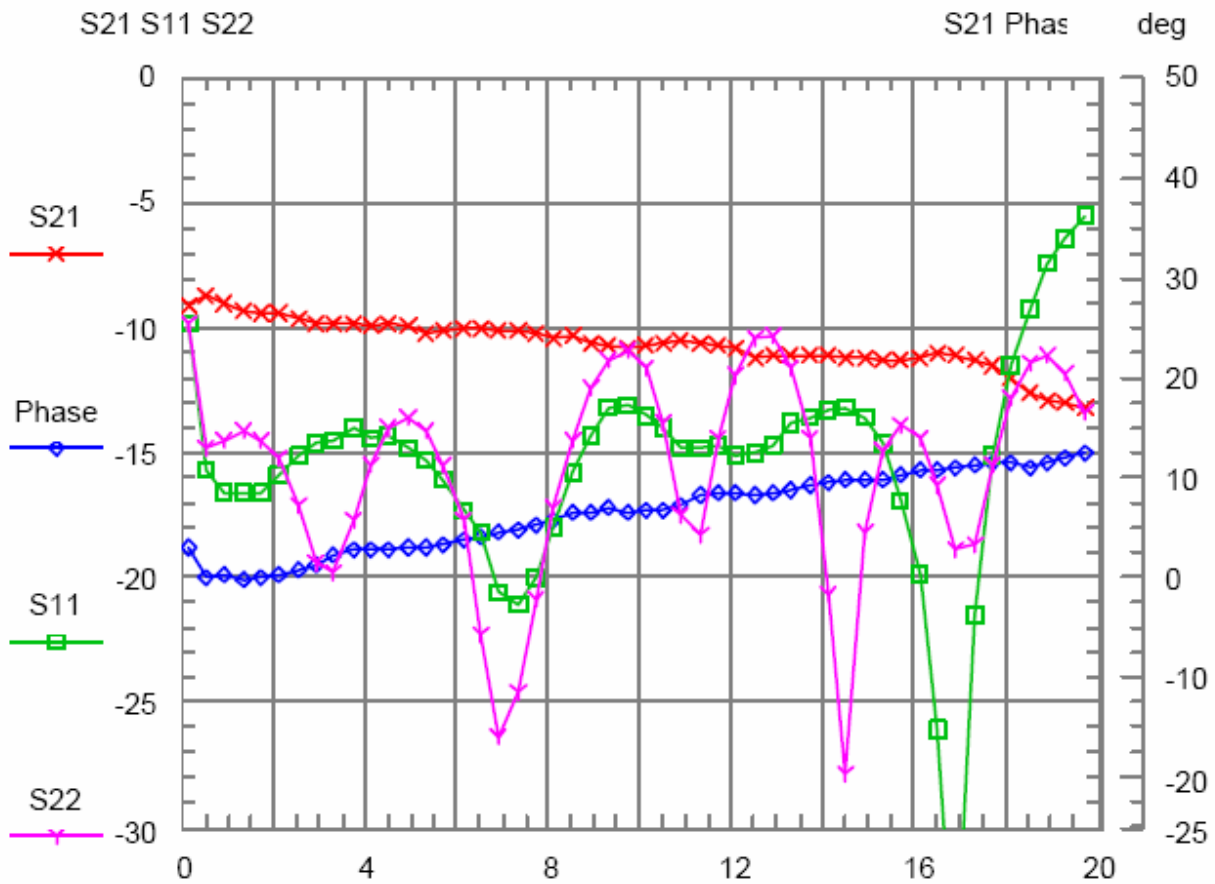

ATN2P1 25 deg C 5Bit code 0CH ABS S21 REL Phase 18NOV2003



**ABSOLUTE INSERTION LOSS
RETURN LOSS
RELATIVE PHASE SHIFT**

CONTROL BITS : 10000

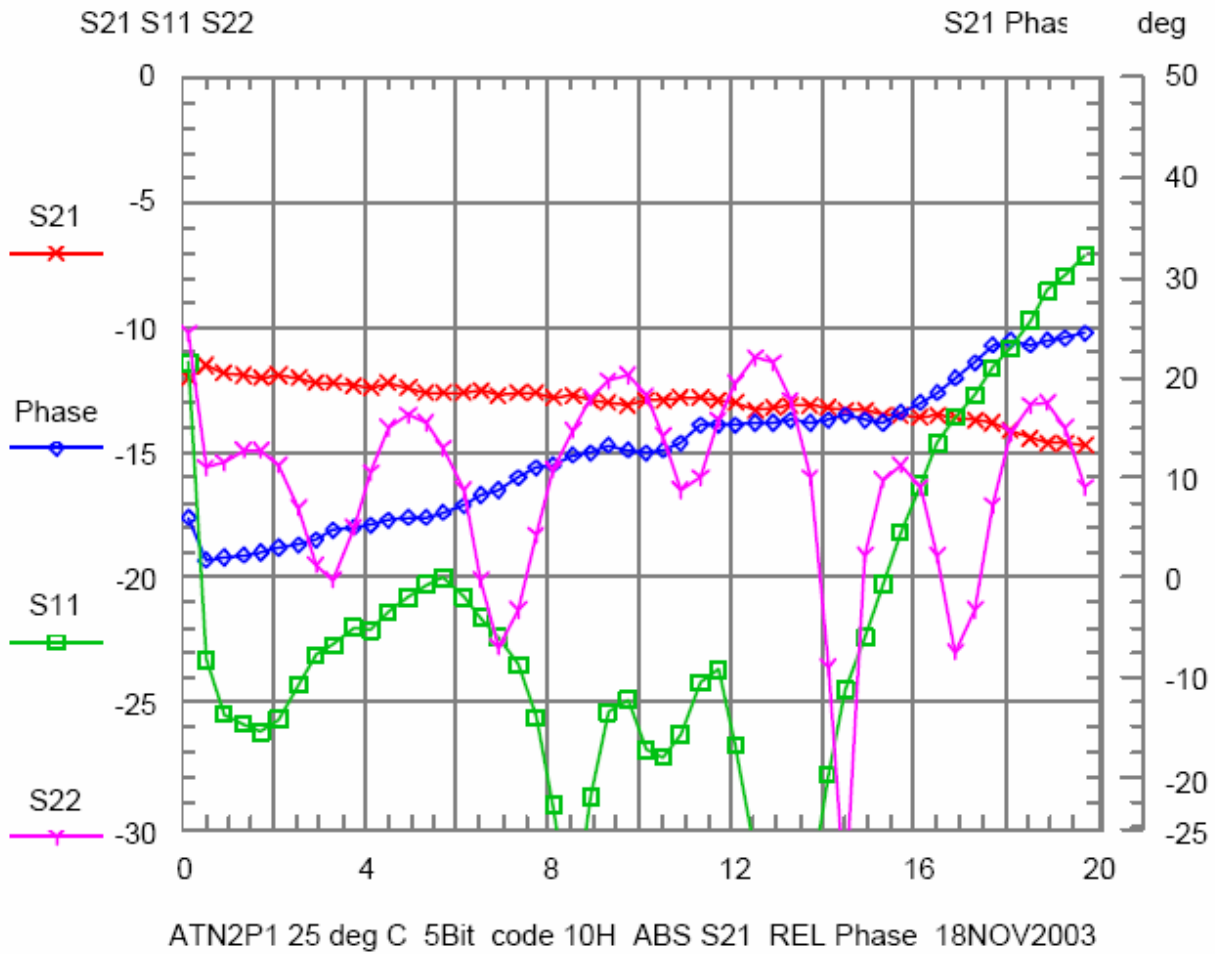



**ABSOLUTE INSERTION LOSS
RETURN LOSS
RELATIVE PHASE SHIFT**

CONTROL BITS : 10100

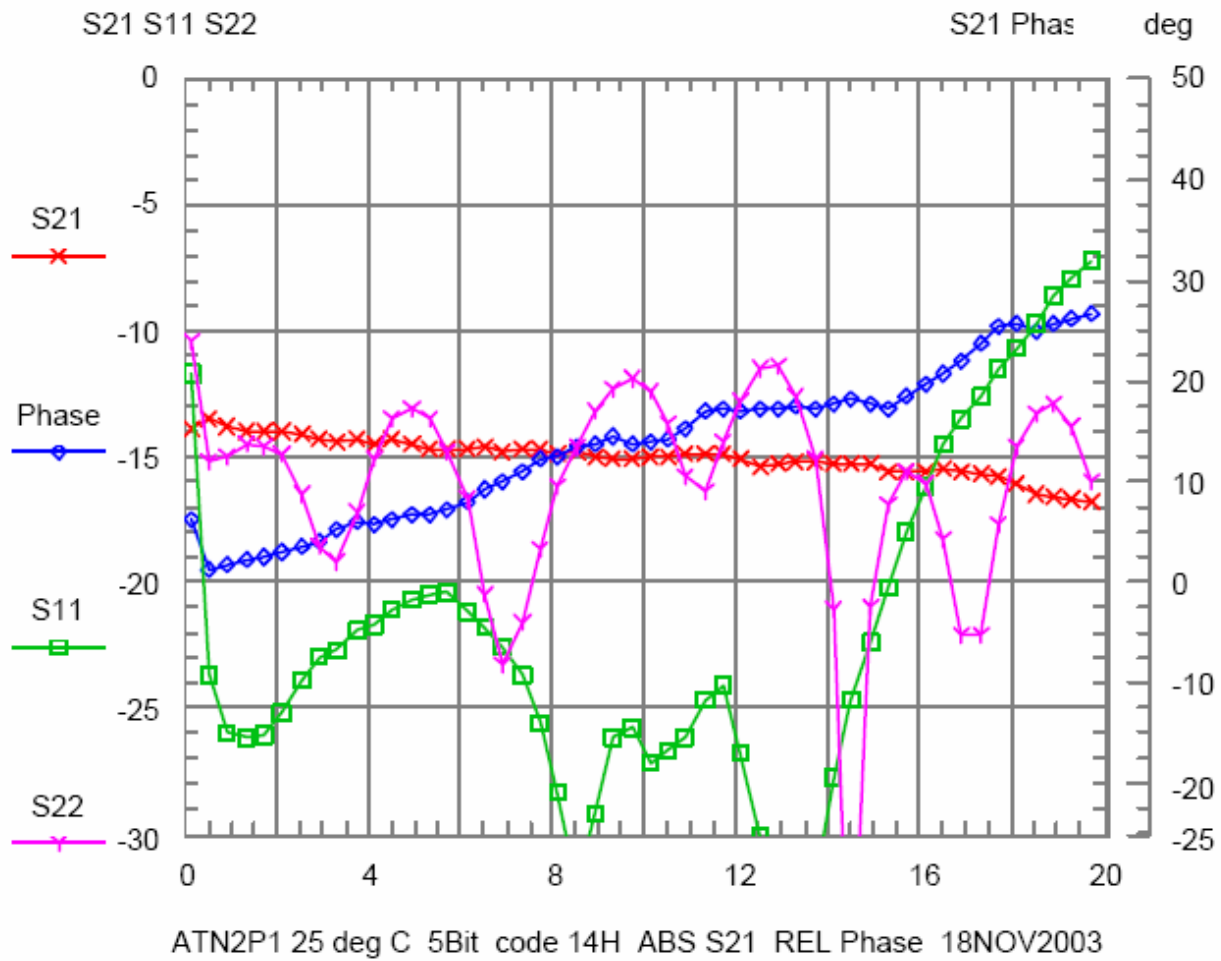



**ABSOLUTE INSERTION LOSS
RETURN LOSS
RELATIVE PHASE SHIFT**

CONTROL BITS : 11000

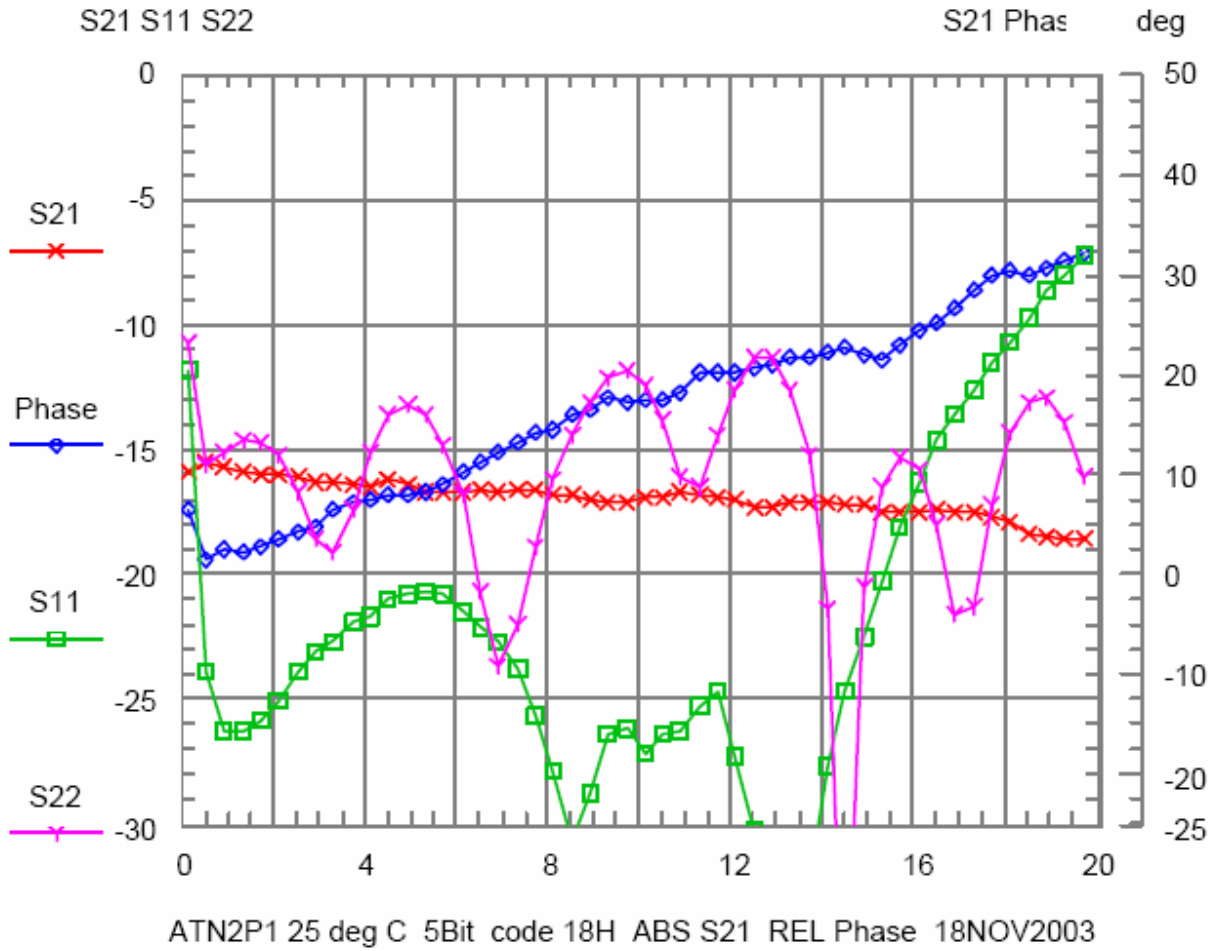



**ABSOLUTE INSERTION LOSS
RETURN LOSS
RELATIVE PHASE SHIFT**

CONTROL BITS : 11100

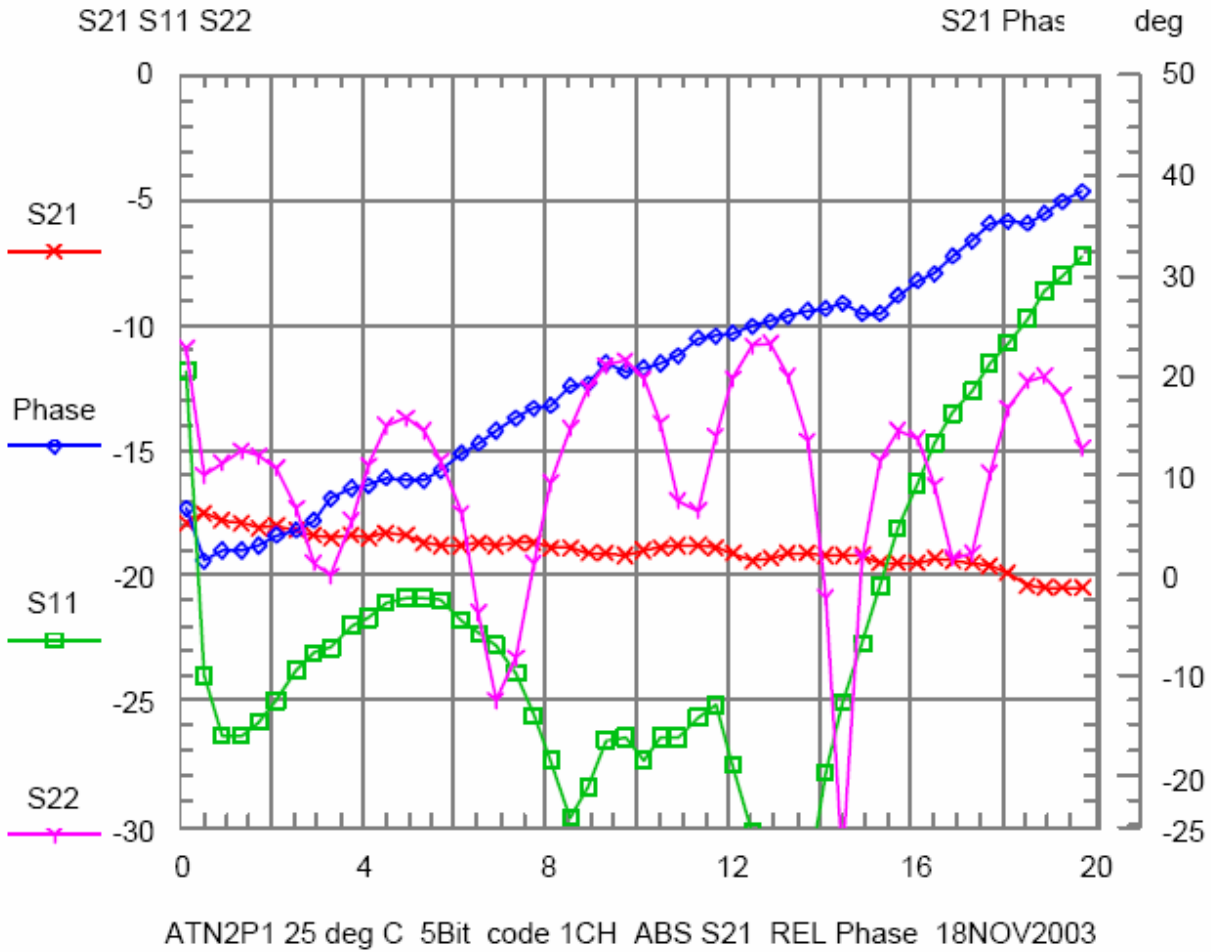



ABSOLUTE INSERTION LOSS
RETURN LOSS
RELATIVE PHASE SHIFT

CONTROL BITS : 11111

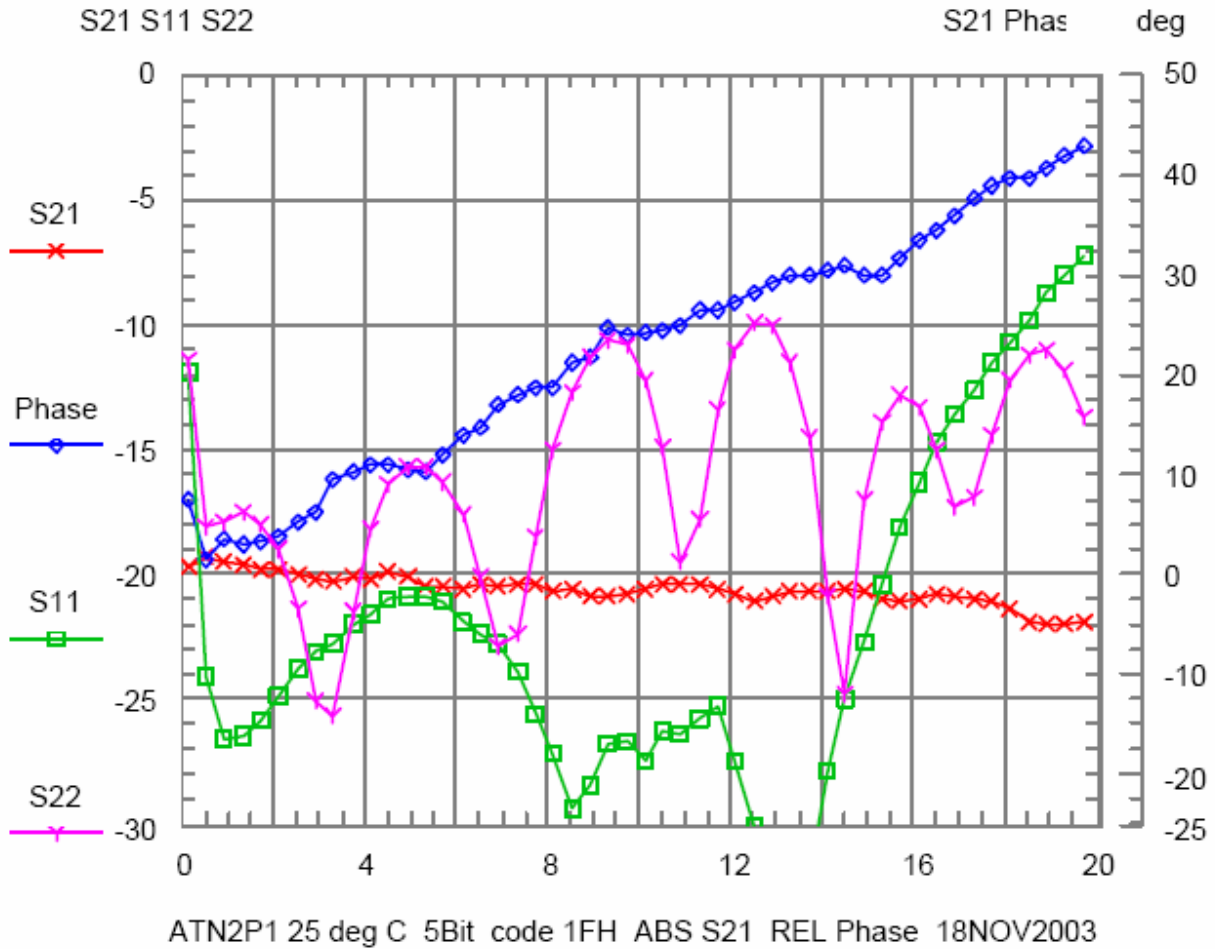



ATN2P1

Uncalibrated RF into tunnel detector.

5 bit digital attenuator. 0.5dB step 15.5 dB range.

Step through all states.

Frequency = 10 GHz

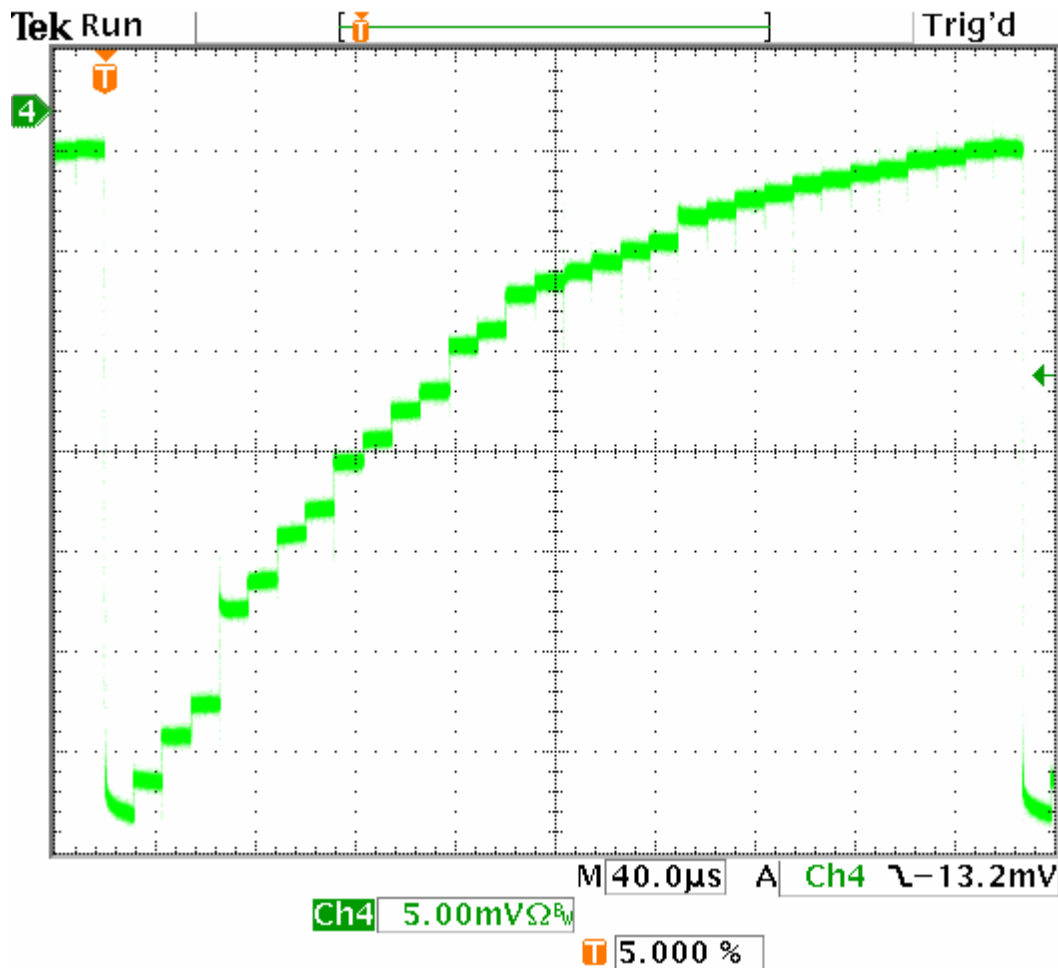



ATN2P1

Uncalibrated RF into tunnel detector.

5 bit digital attenuator. 0.5dB step 15.5 dB range.

Step through all states.

Frequency = 2 GHz

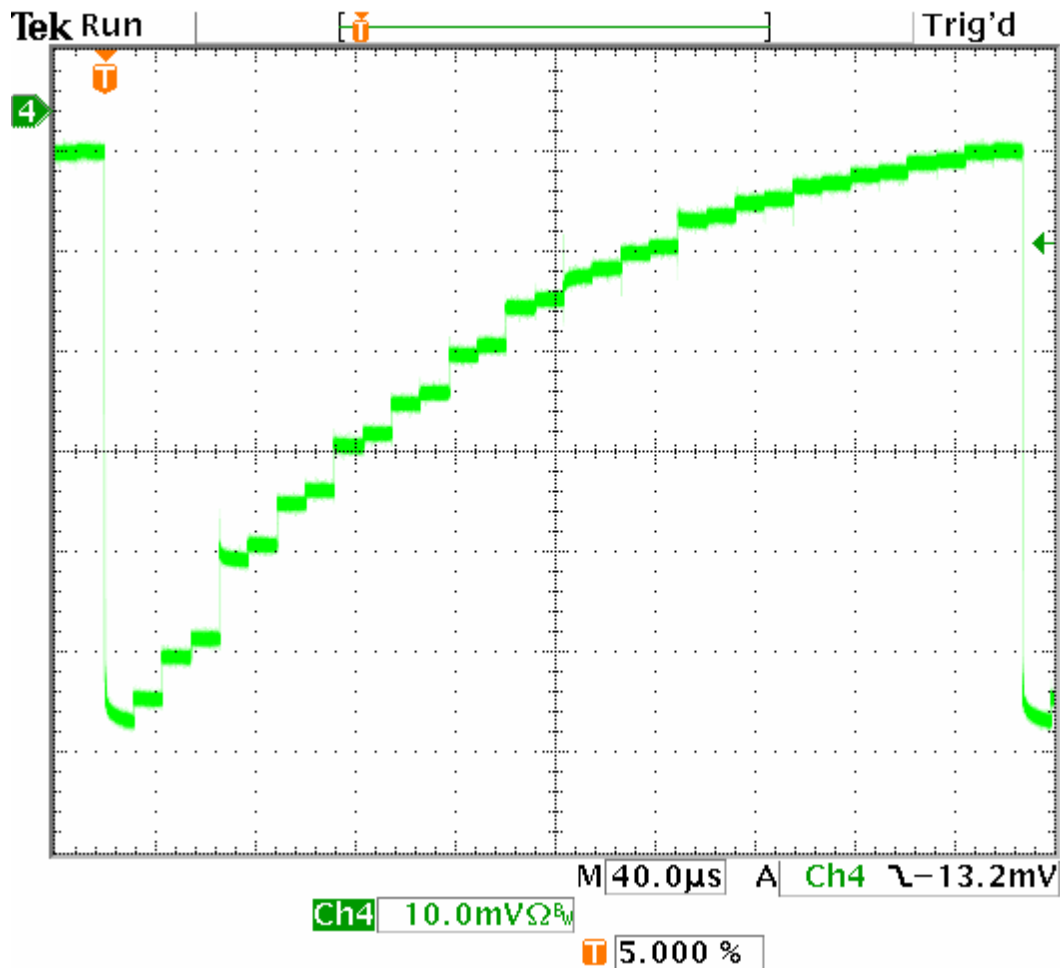



ATN2P1

Uncalibrated RF into tunnel detector.

5 bit digital attenuator. 0.5dB step 15.5 dB range.

Step through all states.

Frequency = 18 GHz

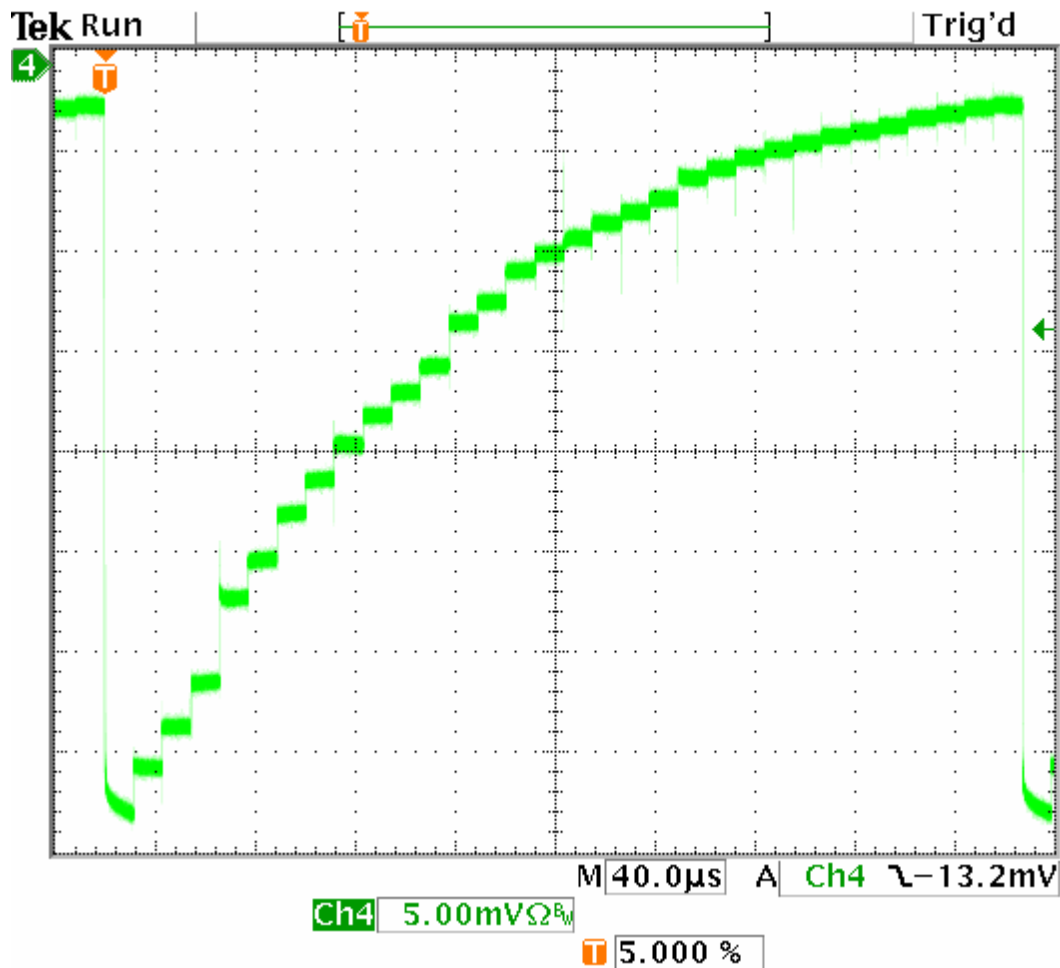



ATN2P1

Uncalibrated RF into tunnel detector.

5 bit digital attenuator. 0.5dB step 15.5 dB range.

Frequency = 10 GHz

BLUE TRACE : TTL INPUT
GREEN TRACE : DETECTED OUTPUT

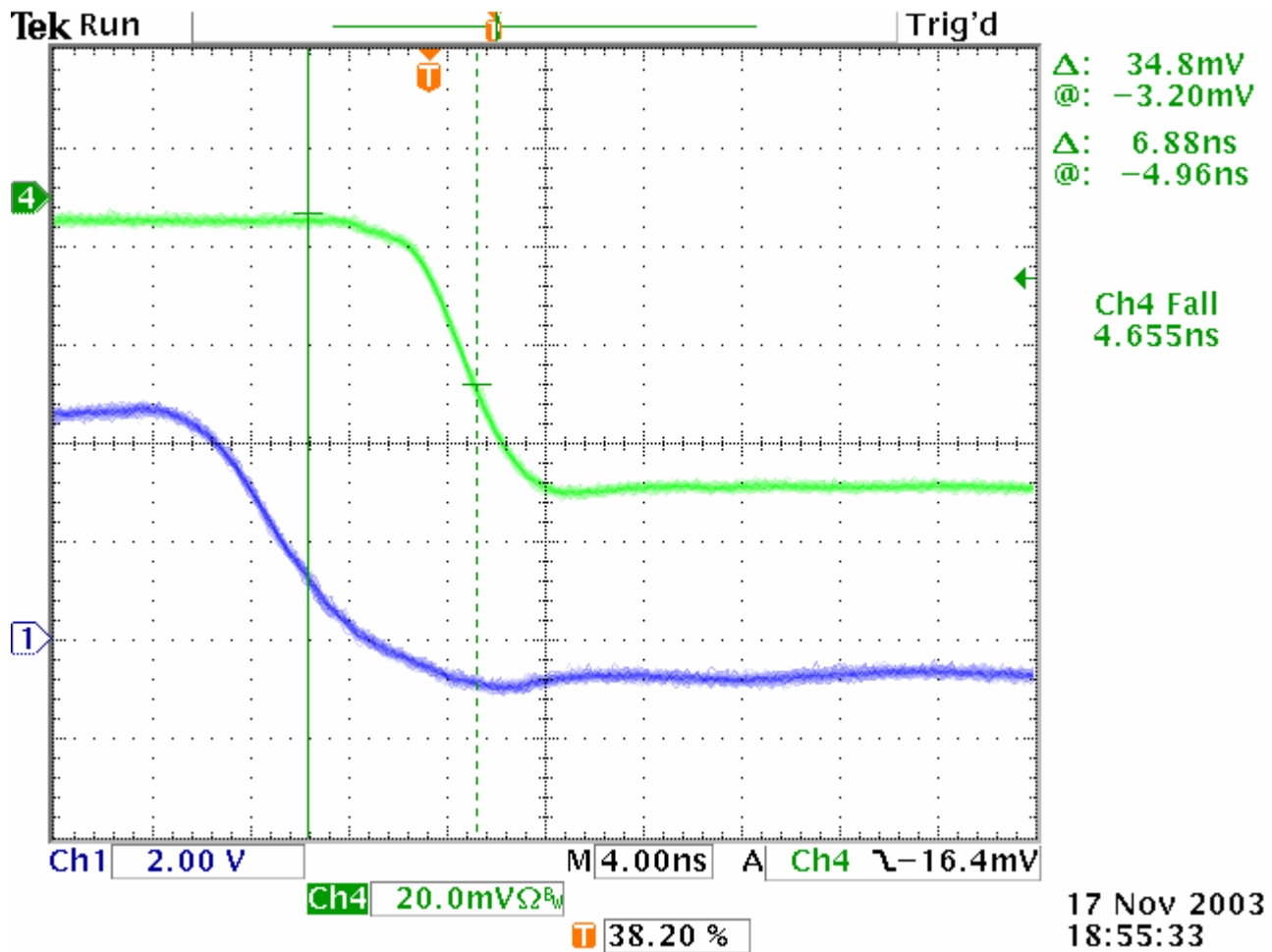



ATN2P1

Uncalibrated RF into tunnel detector.

5 bit digital attenuator. 0.5dB step 15.5 dB range.

Frequency = 10 GHz

BLUE TRACE : TTL INPUT
GREEN TRACE : DETECTED OUTPUT

